

YDS-IRSW-OS05A10 V3.0

5MP OmniVision OS05A10 IR Switch MIPI-Schnittstelle M12 Kameramodul mit Festfokus

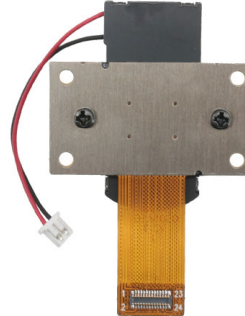
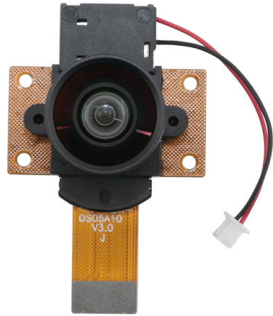

Kameramodul Nr.	YDS-IRSW-OS05A10 V3.0
Auflösung	5MP
Bildsensor	OS05A10
Sensorart	1/2.7"
Pixel Größe	2.0 um x 2.0 um
EFL	2.02 mm
F.NO	2.50
Pixel	2688 x 1944
Betrachtungswinkel	121.4°(DFOV) 107.6°(HFOV) 87.2°(VFOV)
Linsenabmessungen	16.50 x 16.50 x 21.20 mm
Modulgröße	46.70 x 30.00 mm
Modultyp	Fester Fokus
IR Switch Automatische Steuerung	3.3V - 5.5V
Linsenfilter IR-Frequenz	645nm +/- 15nm
Lens Filter AR-Frequenz	700nm - 1,000nm
Betrieb (IR-Tageszeit)	Rote Linie: Negativ Schwarze Linie: Positiv
Betrieb (bei Nacht)	Rote Linie: Positiv Schwarze Linie: Negativ
Anschluss für IR-Schalter	962-10231-030005 (2 Pin)
Schnittstelle	MIPI
Betriebstemperatur	-30°C to +85°C
Gegenstecker	WP7A-S024VA1

YDS-IRSW-OS05A10 V3.0

5MP OmniVision OS05A10 IR Switch MIPI-Schnittstelle M12 Kameramodul mit Festfokus



Ansicht von oben



Seitenansicht



Untersicht

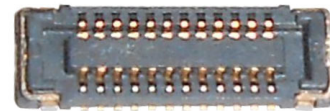

Gegenstecker

RoHS

PIN	SIGNAL
1	AGND
2	AVDD2.8V
3	SDA
4	SCL
5	PWDN
6	RST/XSHUNDN
7	MCP
8	MCN
9	DGND
10	MDP0
11	MDN0
12	DGND
13	MDP1
14	MDN1
15	DGND
16	MDP2
17	MDN2
18	DGND
19	MDP3
20	MDN3
21	DGND
22	DVDD1.2V
23	DOVDD1.8V
24	MCLK

Version	Information	Date
V1.0	First Version	9-9-2019
V2.0	Change screw holes and ICR	11-1-2019
V3.0	Change lens and IR CUT	12-27-2022

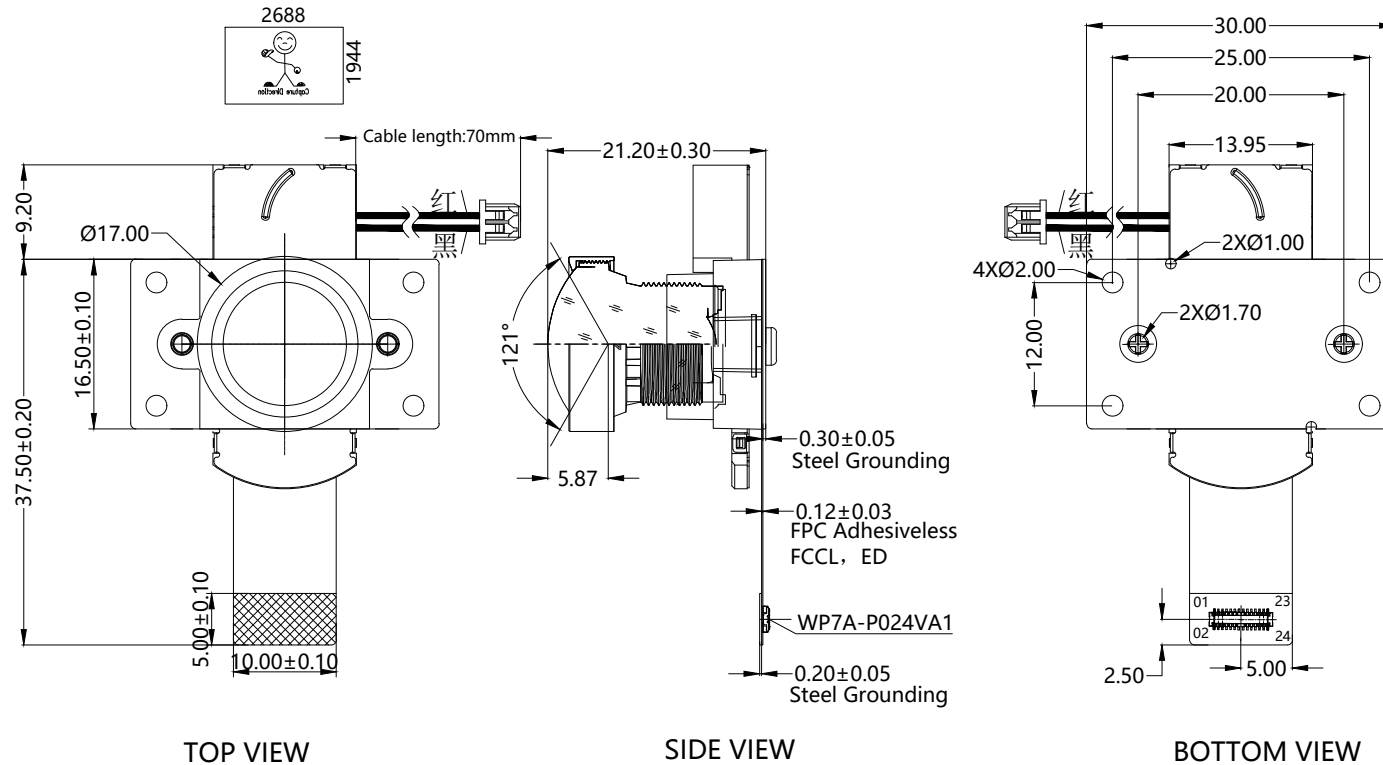

NOTE:
1.The device slave address:0x6C;

Parameter:	
1、 Sensor specification: Image Sensor: OS05A10 Pixel: 2um*2um Lens Type: 1/2.7 Important Voltage Description: DVDD1.2V (external power supply);	2、 Lens specification: FOV: $121.4^\circ(\text{D});107.6^\circ(\text{H});87.2^\circ(\text{V})$; F/NO.: 2.5 TV distortion: $<-3.6\%$ Focal length: 2.02mm Composition: 2G4P+IR CUT

Designed By	Kevin	Model Name:	IRSW-OS05A10 V3.0		
Checked By	Aouly_Yan	Projection Type:	Unit:	Material:	
		 Third Angle	mm	-----	
		Scale:	Sheet:	Version:	
		1:1	1 of 1	1/0	

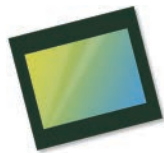

OS05A10 5-megapixel product brief



Versatile 5-Megapixel PureCel® Sensor with High Dynamic Range for a Wide Range of Commercial Security and Consumer Applications



available in
a lead-free
package

OmniVision's low-power OS05A10 is a 5-megapixel image sensor that brings crisp 1080p high definition, 2K, and 5-megapixel video to a wide range of commercial security and consumer applications, including 360-degree full-view cameras. Built on OmniVision's advanced PureCel® pixel architecture, the OS05A10 utilizes backside illumination (BSI) technology to deliver enhanced low-light sensitivity and wide field of view (FOV).

Available in the popular 1/2.7-inch optical format, the OS05A10 enables video applications in widely used 4:3 and 16:9 aspect ratios. The sensor can capture 1080p full high definition slow-motion video at 120 frames per second (fps) and 2688 x 1944 resolution at 60 fps.

Additionally, the OS05A10 features a 11-degree chief ray angle (CRA) and a dual-exposure staggered high dynamic range (HDR) mode to enable excellent scene reproduction in difficult high-contrast lighting conditions.

The OS05A10 is compatible with MIPI and LVDS interfaces and comes in a chip scale package (CSP).

Find out more at www.ovt.com.



Applications

- Security Cameras
- High Resolution Consumer Cameras
- Action Cameras

Product Features

- 2 μm x 2 μm pixel
- optical size of 1/2.7"
- programmable controls for:
 - frame rate
 - mirror and flip
 - cropping
 - windowing
- supports output formats:
 - 12-/10-bit RAW RGB
- supports image sizes:
 - 5MP (2688x1944)
 - 1080p (1920x1080)
 - 720p (1280x720)
- supports 2x2 binning
- standard serial SCCB interface
- 12/10-bit ADC
- up to 4-lane MIPI/LVDS serial output interface (supports maximum speed up to 1500 Mbps/lane)
- 2-exposure staggered HDR support
- programmable I/O drive capability
- light sensing mode (LSM)
- PLL with SCC support
- support for frame sync

OS05A10

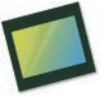

Ordering Information

- OS05A10-H73A-1B (color, lead-free)
73-pin CSP

Product Specifications

- active array size: 2688 x 1944
- maximum image transfer rate:
 - 2688x1944: 60 fps
 - 2688x1520: 60 fps
- power supply:
 - core: 1.2V
 - analog: 2.8V
 - I/O: 1.8V
- power requirements:
 - active: 210 mW
 - standby: 2 mA
 - XSHUTDOWN: 2 μA
- temperature range:
 - operating: -30°C to +85°C junction temperature
 - stable image: 0°C to +60°C junction temperature
- output formats: 10/12-bit RGB RAW
- lens size: 1/2.7"
- lens chief ray angle: 11° linear
- scan mode: progressive
- pixel size: 2.0 μm x 2.0 μm
- image area: 5434.56 μm x 3948.05 μm

Functional Block Diagram

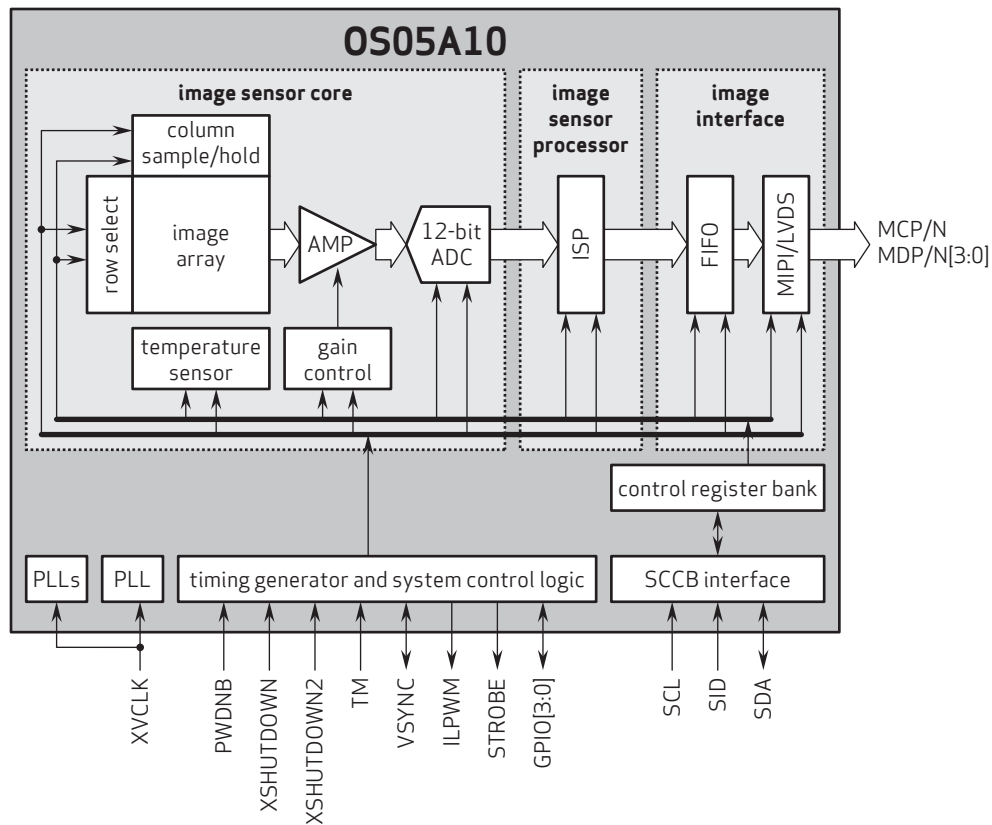

4275 Burton Drive
Santa Clara, CA 95054
USA

Tel: + 1 408 567 3000
Fax: + 1 408 567 3001
www.ovt.com

OmniVision reserves the right to make changes to their products or to discontinue any product or service without further notice. OmniVision, the OmniVision logo and PureCel are registered trademarks of OmniVision Technologies, Inc. All other trademarks are the property of their respective owners.



OmniVision

NEW



0.4mm Pitch, Stacking Type
Board-to-Board (FPC) Connector

CONNECTOR

MB-0228-3

September 2017

WP7 Series

RoHS Compliant

Plug

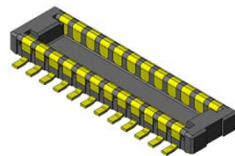

Plug

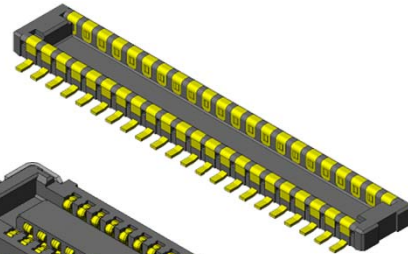

Receptacle

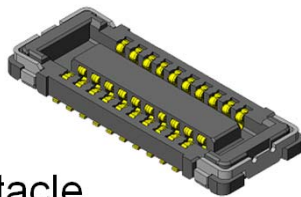

Receptacle

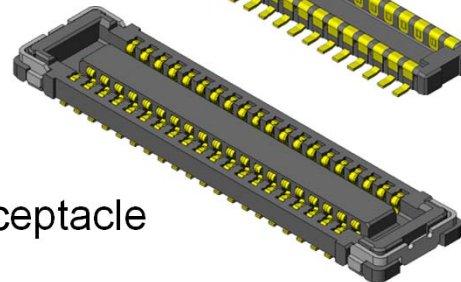

The WP7 Series is a low-profile board-to-board (FPC) connector with 0.4mm pitch spacing that is ideal for high-density mounting in slim information communication devices like mobile phones, smartphones, LCD, and notebook PC.

To satisfy different product function requirements, a low pin count type and a high pin count type (WP7A / WP7B) are available with the same mounting pattern.

Features

- 0.4mm pitch, 2 rows, 0.7mm stacking height.
- Contact structure ensures high wear-resistance and high contact reliability.
- Secure hold-downs prevent insulator breakage and peeling from FPC.
- 2-point contact design to resist twisting stress.
- Pb-free (Ni barrier on contact prevents solder wicking.)
- Receptacle contacts adopt an optimal configuration according to the pin counts.
High removal force WP7A (low pin count: 10-32 pos.)
Low insertion force WP7B (high pin count 34-70 pos.)
- Signal contact supports 10 Gbps transmission rate.
- Supports MIPI, USB3.1 Gen2, and PCIe Gen3 transmission.

General Specifications

- | | |
|---|---|
| <ul style="list-style-type: none"> ■(WP7A) No. of Contacts:
10, 16, 20, 22, 24, 26,
28, 30, 32 pos. ■(WP7B) No. of Contacts:
34, 40, 50, 60, 70 pos. ■Pitch: 0.4mm, 2 rows ■Operating Temperature:
-40 Deg. C to +85 Deg. C ■Contact Resistance:
70mΩ max. (initial) ■Life Time: 30 mating cycles | <ul style="list-style-type: none"> ■Rated Current: AC, DC 0.3A each per terminal ■Rated Voltage: AC, DC 50V ■Insulation Resistance: 100MΩ min. (initial) ■Dielectric Withstanding Voltage:
AC250Vr.m.s for 1 minute ■(WP7A) total insertion force:
1.50N x n max. (n: No. of pos.) ■(WP7A) total removal force:
0.15N x n min. (n: No. of pos.) ■(WP7B) total insertion force:
1.00N x n max. (n: No. of pos.) ■(WP7B) total removal force:
0.10N x n min. (n: No. of pos.) |
|---|---|

Materials and Finishes

Component	Material / Finish
Contact	Cu alloy / Au plating
Insulator	Heat-resistant plastic
Hold-Down	Plug: Cu alloy / Au plating Receptacle: Cu alloy / Sn plating

Ordering Information (Plug)

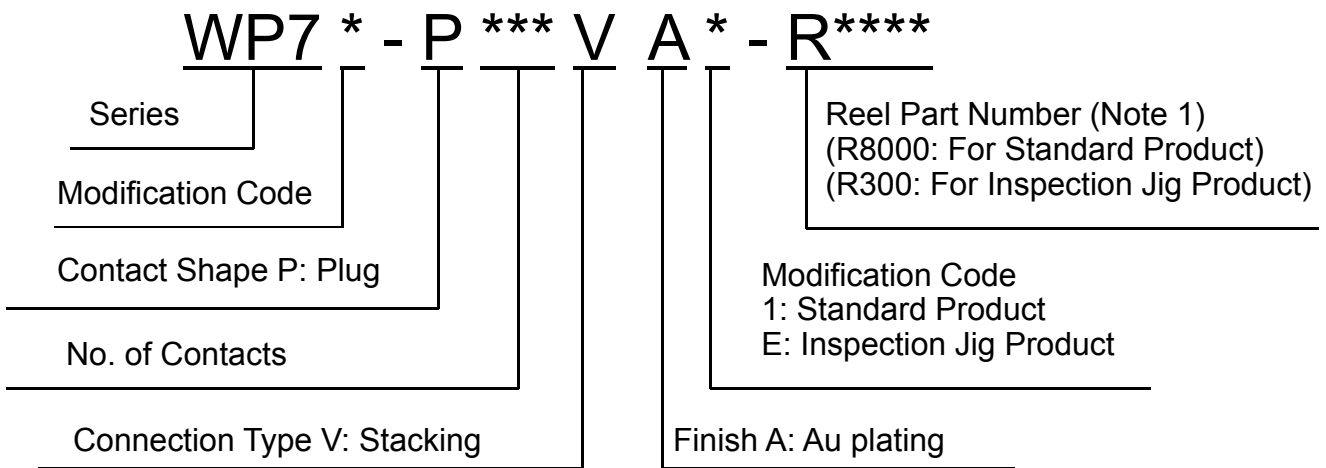

Ordering Information (Receptacle)

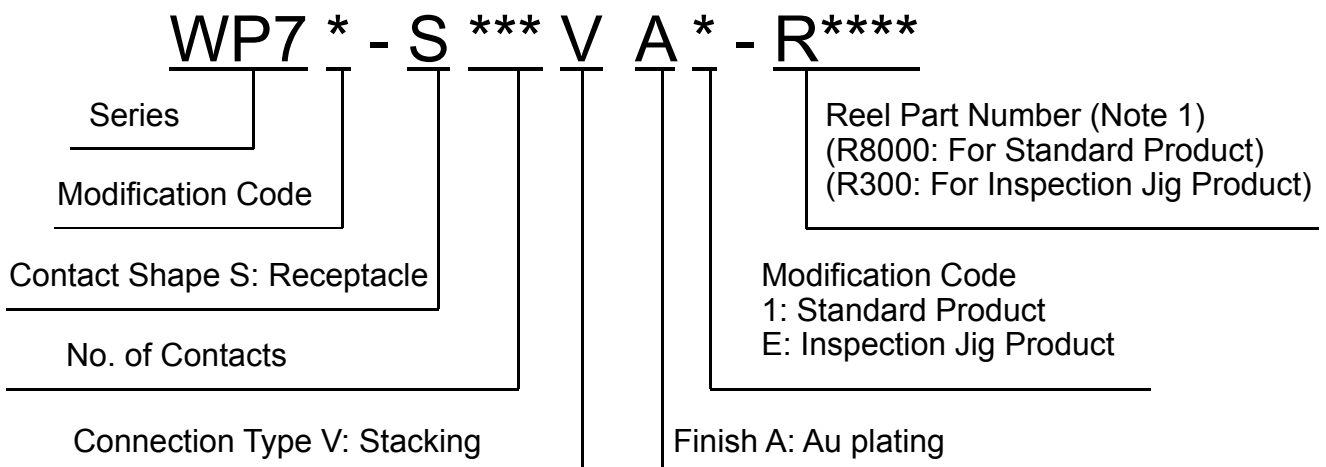

Note 1) An embossed tape reel contains 8,000 pieces of standard product, or 300 pieces of inspection jig product.
Please contact us for details on embossed tape specifications.

Part Number	WP7A-S***VA1
SJ Drawing	SJ111877

WP7A Receptacle

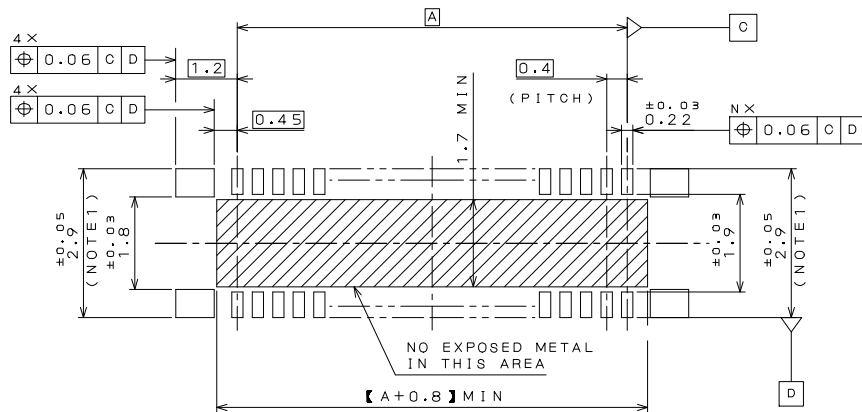
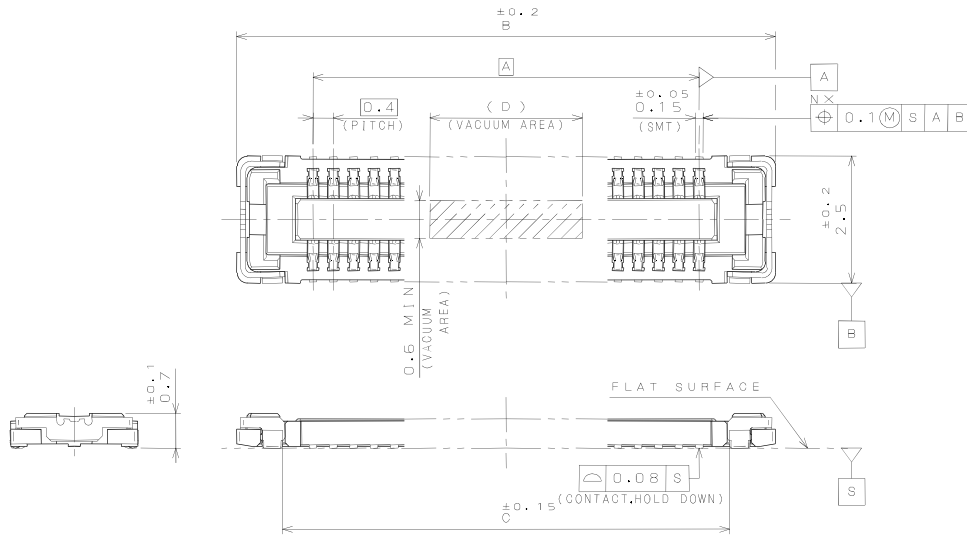

APPLICABLE P.C.B. DIMENSION (REF.)
適合基板寸法 (参考)

NUMBER OF CONTACT 芯数	DIMENSIONS 寸法			
	A	B	C	D
10	1.6	4.6	2.8	2.0
16	2.8	5.8	4.0	2.0
20	3.6	6.6	4.8	2.0
22	4.0	7.0	5.2	2.0
24	4.4	7.4	5.6	2.0
26	4.8	7.8	6.0	5.0
28	5.2	8.2	6.4	5.0
30	5.6	8.6	6.8	5.0
32	6.0	9.0	7.2	5.0

Note 1) Dimension 3.5 ± 0.05 is recommended in case repair is needed.

NEW



0.4mm Pitch, Stacking Type
Board-to-Board (FPC) Connector

CONNECTOR

MB-0228-3

September 2017

WP7 Series

RoHS Compliant

Plug

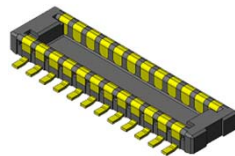

Plug

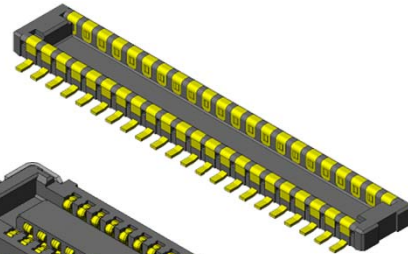

Receptacle

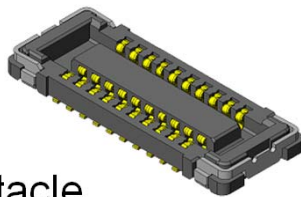

Receptacle

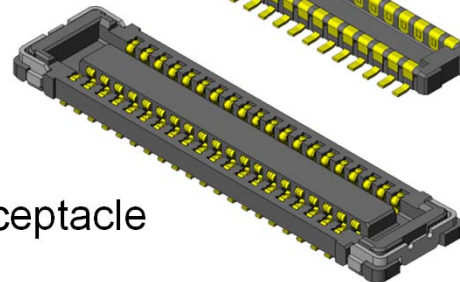

The WP7 Series is a low-profile board-to-board (FPC) connector with 0.4mm pitch spacing that is ideal for high-density mounting in slim information communication devices like mobile phones, smartphones, LCD, and notebook PC.

To satisfy different product function requirements, a low pin count type and a high pin count type (WP7A / WP7B) are available with the same mounting pattern.

Features

- 0.4mm pitch, 2 rows, 0.7mm stacking height.
- Contact structure ensures high wear-resistance and high contact reliability.
- Secure hold-downs prevent insulator breakage and peeling from FPC.
- 2-point contact design to resist twisting stress.
- Pb-free (Ni barrier on contact prevents solder wicking.)
- Receptacle contacts adopt an optimal configuration according to the pin counts.
High removal force WP7A (low pin count: 10-32 pos.)
Low insertion force WP7B (high pin count 34-70 pos.)
- Signal contact supports 10 Gbps transmission rate.
- Supports MIPI, USB3.1 Gen2, and PCIe Gen3 transmission.

General Specifications

- | | |
|---|---|
| <ul style="list-style-type: none"> ■(WP7A) No. of Contacts:
10, 16, 20, 22, 24, 26,
28, 30, 32 pos. ■(WP7B) No. of Contacts:
34, 40, 50, 60, 70 pos. ■Pitch: 0.4mm, 2 rows ■Operating Temperature:
-40 Deg. C to +85 Deg. C ■Contact Resistance:
70mΩ max. (initial) ■Life Time: 30 mating cycles | <ul style="list-style-type: none"> ■Rated Current: AC, DC 0.3A each per terminal ■Rated Voltage: AC, DC 50V ■Insulation Resistance: 100MΩ min. (initial) ■Dielectric Withstanding Voltage:
AC250Vr.m.s for 1 minute ■(WP7A) total insertion force:
1.50N x n max. (n: No. of pos.) ■(WP7A) total removal force:
0.15N x n min. (n: No. of pos.) ■(WP7B) total insertion force:
1.00N x n max. (n: No. of pos.) ■(WP7B) total removal force:
0.10N x n min. (n: No. of pos.) |
|---|---|

Materials and Finishes

Component	Material / Finish
Contact	Cu alloy / Au plating
Insulator	Heat-resistant plastic
Hold-Down	Plug: Cu alloy / Au plating Receptacle: Cu alloy / Sn plating

Ordering Information (Plug)

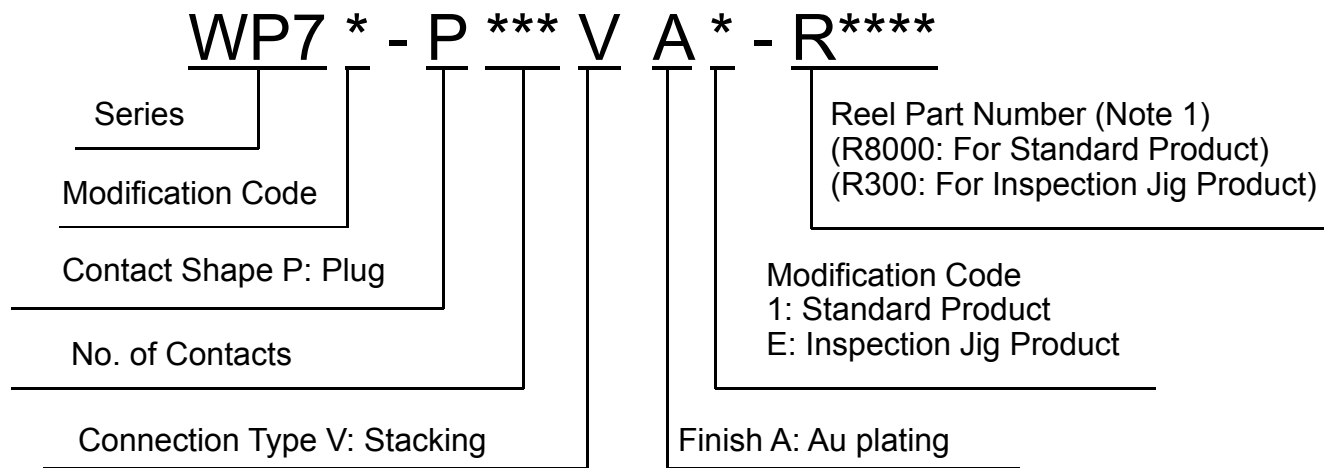

Ordering Information (Receptacle)

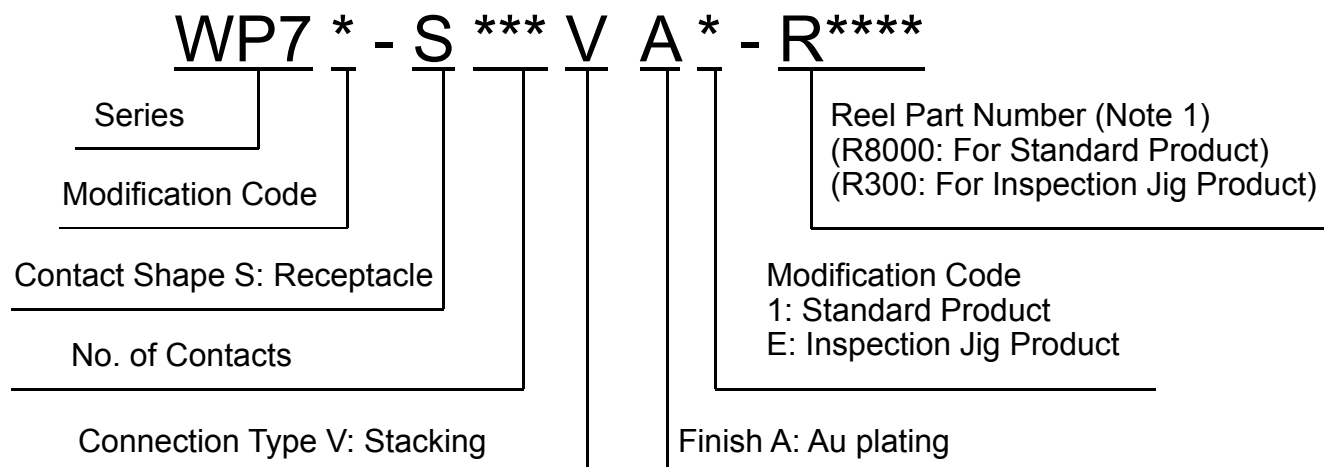

Note 1) An embossed tape reel contains 8,000 pieces of standard product, or 300 pieces of inspection jig product.
Please contact us for details on embossed tape specifications.

Part Number	WP7A-S***VA1
SJ Drawing	SJ111877

WP7A Receptacle

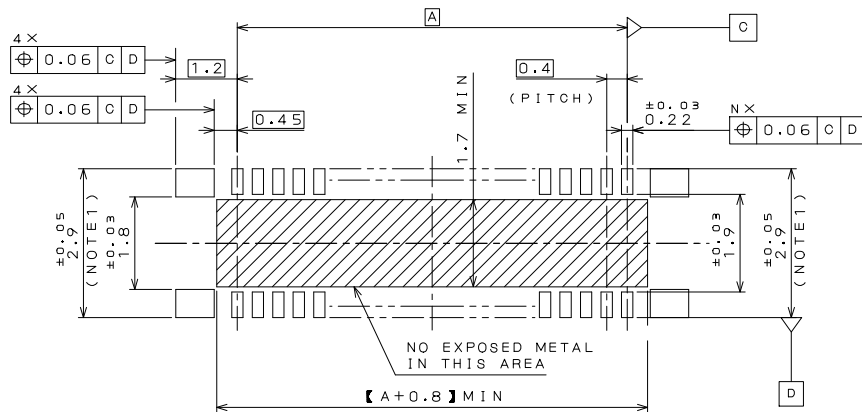
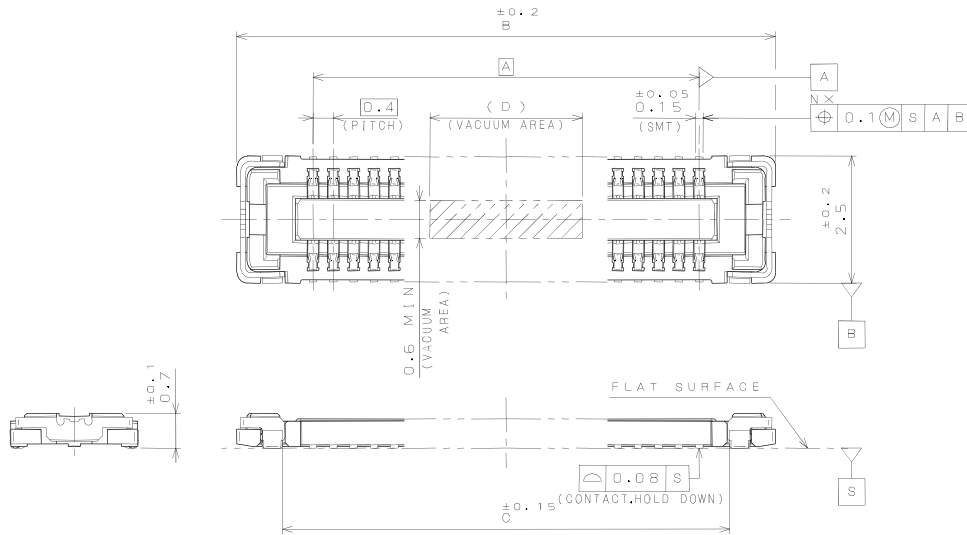

APPLICABLE P.C.B. DIMENSION (REF.)
適合基板寸法 (参考)

DIMENSIONS 寸法 NUMBER OF CONTACT 芯数	DIMENSIONS			
	A	B	C	D
10	1.6	4.6	2.8	2.0
16	2.8	5.8	4.0	2.0
20	3.6	6.6	4.8	2.0
22	4.0	7.0	5.2	2.0
24	4.4	7.4	5.6	2.0
26	4.8	7.8	6.0	5.0
28	5.2	8.2	6.4	5.0
30	5.6	8.6	6.8	5.0
32	6.0	9.0	7.2	5.0

Note 1) Dimension 3.5±0.05 is recommended in case repair is needed.

Kameraanwendungen



Autopilot



Live-Streaming



Videokonferenz



Biometrische Eye-Tracker-Erkennung

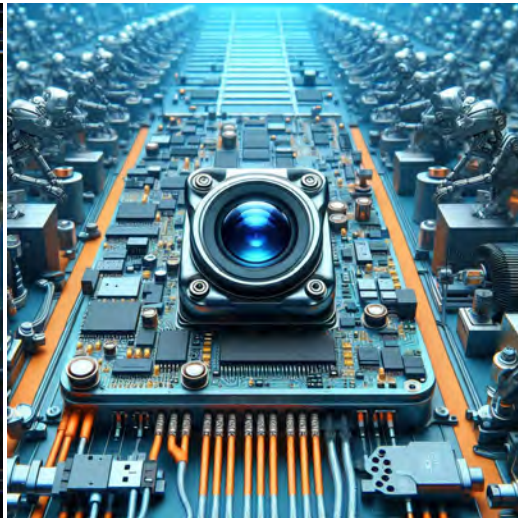

Maschinelles Sehen



Agrarmonitor



Nachtsichtsicherheit



Drohnen- und Sport-Adleraugen



Interaktive Haustierkamera



Referenztable für die Pinbelegungsdefinition des Kameramoduls

OmniVision Sony Himax Samsung On-Semi Aptina Himax GalaxyCore PixArt Bildsensoren	
Pin Signal	Beschreibung
DGND GND	Masse für digitale Schaltung
AGND	Masse für analoge Schaltung
PCLK DCK	DVP-PCLK-Ausgang
XCLR PWDN XSHUTDOWN STANDBY	Abschalten aktiv hoch mit internem Pulldown-Widerstand
MCLK XVCLK XCLK INCK	Systemeingangsuhr
RESET RST	Aktiv Low mit internem Pull-up-Widerstand zurücksetzen
NC NULL	keine Verbindung
SDA SIO_D SIOD	SCCB-Daten
SCL SIO_C SOIC	SCCB-Eingangstakt
VSYNC XVS FSYNC	DVP-VSYNC-Ausgang
HREF XHS	DVP-HREF-Ausgang
DOVDD	Strom für E/A-Schaltung
AFVDD	Strom für VCM-Schaltung
AVDD	Strom für analoge Schaltung
DVDD	Strom für digitale Schaltung
STROBE FSTROBE	Strobe-Ausgang
FSIN	Synchronisieren Sie das VSYNC-Signal vom anderen Sensor
SID	SCCB letzte Bit-ID-Eingabe
ILPWM	mechanische Shutter-Ausgangsanzeige
FREX	Rahmenbelichtung / mechanischer Verschluss
GPIO	Allzweckeingänge
SLASEL	I2C-Slave-Adresse auswählen
AFEN	CEN-Chip aktivieren aktiv hoch auf VCM-Treiber-IC
MIPI Schnittstelle	
MDN0 DN0 MD0N DATA_N DMO1N	MIPI 1st negative Ausgabe der Datenspur
MDP0 DP0 MD0P DATA_P DMO1P	MIPI 1st positiver Ausgang der Datenspur
MDN1 DN1 MD1N DATA2_N DMO2N	MIPI 2nd negative Ausgabe der Datenspur
MDP1 DP1 MD1P DATA2_P DMO2P	MIPI 2nd positiver Ausgang der Datenspur
MDN2 DN2 MD2N DATA3_N DMO3N	MIPI 3rd negative Ausgabe der Datenspur
MDP2 DP2 MD2P DATA3_P DMO3P	MIPI 3rd positiver Ausgang der Datenspur
MDN3 DN3 MD3N DATA4_N DMO4N	MIPI 4th negative Ausgabe der Datenspur
MDP3 DP3 MD3P DATA4_P DMO4P	MIPI 4th positiver Ausgang der Datenspur
MCN CLKN CLK_N DCKN	MIPI Uhr negativer Ausgang
MCP CLKP MCP CLK_P DCKN	MIPI Takt positiver Ausgang
DVP Parallel Schnittstelle	
D0 DO0 Y0	DVP Datenausgabeport 0
D1 DO1 Y1	DVP Datenausgabeport 1
D2 DO2 Y2	DVP Datenausgabeport 2
D3 DO3 Y3	DVP Datenausgabeport 3
D4 DO4 Y4	DVP Datenausgabeport 4
D5 DO5 Y5	DVP Datenausgabeport 5
D6 DO6 Y6	DVP Datenausgabeport 6
D7 DO7 Y7	DVP Datenausgabeport 7
D8 DO8 Y8	DVP Datenausgabeport 8
D9 DO9 Y9	DVP Datenausgabeport 9
D10 DO10 Y10	DVP Datenausgabeport 10
D11 DO11 Y11	DVP Datenausgabeport 11

Kamera-Zuverlässigkeitstest

Zuverlässigkeitsprüfpunkt		Testmethode	Akzeptanzkriterium	
Kategorie	Artikel			
Umwelt	Lager Temperatur	Hoch 60°C 96 Std	Temperaturkammer	Keine anormale Situation
		Niedrig -20°C 96 Std	Temperaturkammer	Keine anormale Situation
	Betriebs Temperatur	Hoch 60°C 24 Std	Temperaturkammer	Keine anormale Situation
		Niedrig -20°C 24 Std	Temperaturkammer	Keine anormale Situation
	Feuchtigkeit	60°C 80% 24 Std	Temperaturkammer	Keine anormale Situation
	Thermischer Schock	Hoch 60°C 0.5 Std Niedrig -20°C 0.5 Std Radfahren rein 24 Std	Temperaturkammer	Keine anormale Situation
Physisch	Falltest (Im freien Fall)	Ohne Verpackung 60cm	10 Mal auf Holzboden	Elektrisch funktionsfähig
		Mit Paket 60cm	10 Mal auf Holzboden	Elektrisch funktionsfähig
	Vibrations Test	50Hz X-Axis 2mm 30 Minuten	Vibrationstisch	Elektrisch funktionsfähig
		50Hz Y-Axis 2mm 30 Minuten	Vibrationstisch	Elektrisch funktionsfähig
		50Hz Z-Axis 2mm 30 Minuten	Vibrationstisch	Elektrisch funktionsfähig
	Zugfestigkeit des Kabels Krafttest	Gewicht laden 4 kg 60 Sekunden Radfahren rein 24 Std	Zugprüfmaschine	Elektrisch funktionsfähig
Elektrisch	ESD-Test	Kontaktaufnahme 2 KV	ESD-Prüfmaschine	Elektrisch funktionsfähig
		Luftentladung 4 KV	ESD-Prüfmaschine	Elektrisch funktionsfähig
	Alterungstest	On/Off 30 Sekunden Radfahren rein 24 Std	Stromschalter	Elektrisch funktionsfähig
	USB-Anschluss	On/Off 250 Mal	Einstecken und ausstecken	Elektrisch funktionsfähig



Kamerainspektionsstandard

Inspektionsgegenstand		Untersuchungsmethode	Inspektionsstandard	
Kategorie	Artikel			
Aussehen	FPC oder PCB	Farbe	Das bloße Auge	Größere Unterschiede sind nicht zulässig.
		Zerrissen/gehackt werden	Das bloße Auge	Das Freilegen von Kupferrissen ist nicht zulässig.
		Markierung	Das bloße Auge	Klar, erkennbar (innerhalb von 30 cm Entfernung)
	Halterin	Kratzer	Das bloße Auge	Die Freilegung von Rissen im Inneren ist nicht zulässig
		Lücke	Das bloße Auge	Erfüllen Sie den Höhenstandard
		Schraube	Das bloße Auge	Stellen Sie sicher, dass Schrauben vorhanden sind (falls vorhanden)
		Schaden	Das bloße Auge	Die Freilegung von Rissen im Inneren ist nicht zulässig
	Linse	Kratzen	Das bloße Auge	Keine Auswirkung auf den Auflösungsstandard
		Kontamination	Das bloße Auge	Keine Auswirkung auf den Auflösungsstandard
		Ölfilm	Das bloße Auge	Keine Auswirkung auf den Auflösungsstandard
		Abdeckband	Das bloße Auge	Kein Problem beim Aussehen.
	Funktion	Bild	Keine Kommunikation	Testboard
Helles Pixel			Tafel	Im Image Center nicht erlaubt
Dunkles Pixel			Weißer Tafel	Im Image Center nicht erlaubt
Verschwommen			Das bloße Auge	Nicht erlaubt
Kein Bild			Das bloße Auge	Nicht erlaubt
Vertikale Linie			Das bloße Auge	Nicht erlaubt
Horizontale Linie			Das bloße Auge	Nicht erlaubt
Kleines Leck			Das bloße Auge	Nicht erlaubt
Blinkendes Bild			Das bloße Auge	Nicht erlaubt
Prellung			Inspektionslehre	Nicht erlaubt
Auflösung			Diagramm	Folgt dem Diagrammstandard für ausgehende Inspektionen
Farbe			Das bloße Auge	Kein Problem
Lärm			Das bloße Auge	Nicht erlaubt
Ecke dunkel			Das bloße Auge	Weniger als 100 x 100 Pixel
Farbauflösung			Das bloße Auge	Kein Problem
Abmessungen	Höhe	Das bloße Auge	Befolgt Zulassungsdatenblatt	
	Breite	Das bloße Auge	Befolgt Zulassungsdatenblatt	
	Länge	Das bloße Auge	Befolgt Zulassungsdatenblatt	
	Gesamt	Das bloße Auge	Befolgt Zulassungsdatenblatt	

YDSCAM Paketlösungen

YDSCAM Kameramodul



Komplett mit Linsenschutzfolie

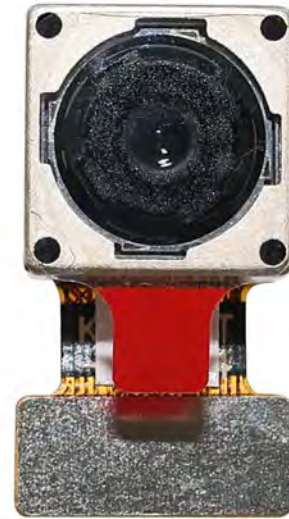

Tablett mit Gitter und Raum



Legen Sie die Kameras auf das Tablett



YDSCAM Paketlösungen

Volles Fach mit Kameras



Decken Sie das Tablett mit dem Deckel ab



Legen Sie das Tablett in den antistatischen Beutel



Staubsaugen Sie den antistatischen Beutel



YDSCAM Paketlösungen

Versiegelter antistatischer Vakuumbbeutel mit Etiketten

1. Modell und Beschreibung 2. Menge 3. Herstellungsdatumscode 4. Achtung



YDSCAM Paketlösungen

Legen Sie Schaumstoffplatten zwischen die Tablettbeutel



Schaumstoffplatten sind größer als Tablettbeutels



Legen Sie Schaumstoffplatten und Tablettbeutels in den Karton



Die Schaumstoffplatten sitzen fest im Karton



Verschließen Sie die Carbon Box



Beschriften Sie den Carbon-Versandkarton



YDSCAM Paketlösungen

USB-Kameramodul

Komplett mit Objektivschutzfolie

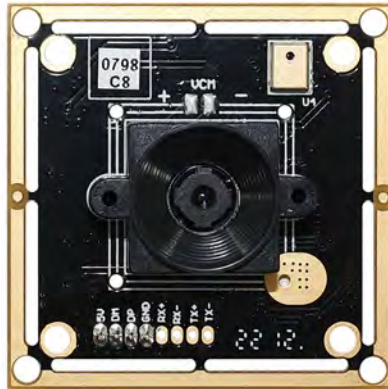

Legen Sie die Kameraprobe in den antistatischen Beutel

Legen Sie USB-Kameras in das Fach



Verschließen Sie das Tablett mit einem antistatischen Beutel

Beschriften Sie den Carbon-Versandkarton



YDSCAM Paketlösungen

Legen Sie die Kameraprobe in den antistatischen Beutel



Legen Sie die Steckverbinder in den antistatischen Beutel



Beschriften Sie die Probenbeutel



Stecken Sie die Steckverbinder in die Spule



Legen Sie Proben in die Carbonbox



Stecken Sie die Steckverbinder in die Carbonbox





Firma YDSCAM

YingDeShun Co. Ltd. (YDS) wurde 2017 gegründet, ein technologieorientierter Hersteller der nächsten Generation, der sich auf Forschung, Design und Produktion von Audio- und Videoprodukten spezialisiert hat. YDS verfügt über 20.000 Quadratmeter große automatisierte Anlagen mit 100 Mitarbeitern und einem Jahresdurchsatz von 30.000.000 Kameraeinheiten.

YDS bietet OEM- und ODM-Design sowie Auftragsfertigung und baut die Kameraprodukte. Sie können uns die Anforderungen mitteilen, sogar mit einem Handentwurf. Unser Vertrieb und unsere Technik arbeiten zusammen, um Ihre Anforderungen zu erfüllen. Wir verstehen uns als Ihr langfristiger Partner bei der Entwicklung praktischer und innovativer Lösungen.

Unser Team deckt alles von der ersten Konzeptentwicklung bis zum Massenprodukt ab. YDS ist auf kundenspezifisches Kameradesign, Rohmaterial, Elektroniktechnik, Firmware-/Softwareentwicklung, Produkttests und Verpackungsdesign spezialisiert. Unsere erfahrenen strategischen Liefersysteme bieten eine robuste und zuverlässige Fertigungskapazität für Aufträge unterschiedlicher Größe.

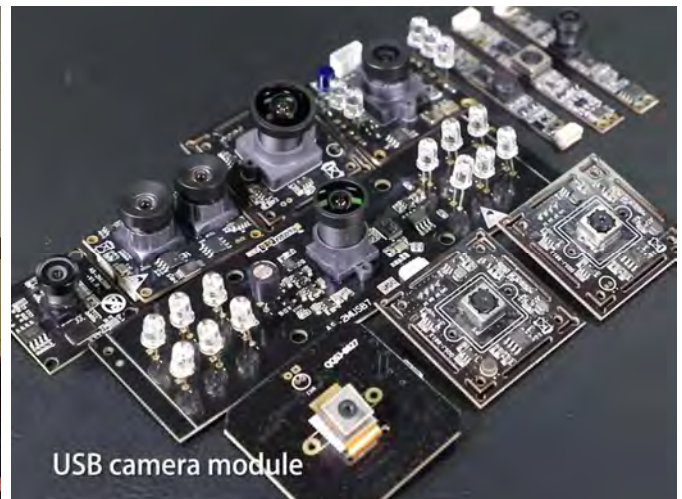

Eingeschränkte Garantie

YDS gewährt die folgende eingeschränkte Garantie, wenn Sie das/die Produkt(e) direkt von der YDS-Firma oder über die YDS-Website www.YDSCAM.com erworben haben. Von anderen Verkäufern oder Quellen gekaufte Produkte fallen nicht unter diese eingeschränkte Garantie. YDS garantiert, dass die Produkte bei normalem Gebrauch für einen Zeitraum von einem (1) Jahr ab dem Datum, an dem Sie das Produkt erhalten („Garanzzeitraum“), frei von Material- und Verarbeitungsfehlern sind.

Für alle Produkte, die während der Garanzzeit wesentliche Material- oder Verarbeitungsfehler aufweisen oder entwickeln, wird YDS nach eigenem Ermessen entweder: (i) das/die Produkt(e) reparieren; (ii) das/die Produkt(e) durch ein/e neue oder generalüberholte(n) Produkt(e) ersetzen (wobei das/die Ersatzprodukt(e) vom identischen Modell oder einer gleichwertigen Funktion sein müssen); oder (iii) Ihnen eine Rückerstattung des Preises gewähren, den Sie für das/die Produkt(e) bezahlt haben.

Diese eingeschränkte Garantie von YDS beschränkt sich ausschließlich auf Reparatur und/oder Ersatz gemäß den oben dargelegten Bedingungen. YDS ist nicht zuverlässig oder verantwortlich für etwaige Folgeereignisse.





YDS CAMERA MODULE

your best camera partner

Unsere Unternehmensstärke

Leistungsstarke Fabrik



Professioneller Service



Versprochene Lieferung



www.YDSCAM.com sales@ydscam.com Phone (WeChat, QQ): (+86) 177 2732 6718

All rights reserved @ YingDeShun Co. Ltd. Specifications subject to change without notice.